

Suspension U-Bolts

Round U-Bolts 1/2"

	Length	39mm	45mm	50mm
Length	4"	UBOLT39X4RD	N/A	N/A
	4.5"	UBOLT39X4.5RD	UBOLT45X4.5RD	UBOLT50X4.5RD
	5"	UBOLT39X5RD	UBOLT45X5RD	UBOLT50X5RD
	5.5"	UBOLT39X5.5RD	UBOLT45X5.5RD	N/A
	6"	N/A	UBOLT45X6RD	UBOLT50X6RD
	6.5"	N/A	N/A	N/A
	7"	N/A	N/A	UBOLT50X7RD

(Supplied with 2 x 1/2" BSW Nuts and spring washers)

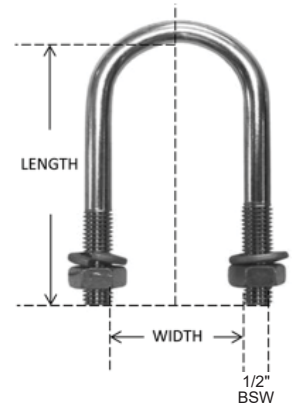

Square U-Bolts 1/2"

	Length	40mm	45mm	50mm
Length	4"	N/A	N/A	N/A
	4.5"	UBOLT40X4.5SQ	UBOLT45X4.5SQ	UBOLT50X4.5SQ
	5"	UBOLT40X5SQ	UBOLT45X5SQ	UBOLT50X5SQ
	5.5"	UBOLT40X5.5SQ	UBOLT45X5.5SQ	N/A
	6"	N/A	UBOLT45X6SQ	UBOLT50X6SQ
	6.5"	N/A	UBOLT45X6.5SQ	UBOLT50X6.5SQ
	7"	N/A	N/A	UBOLT50X7SQ

(Supplied with 2 x 1/2" BSW Nuts and spring washers)

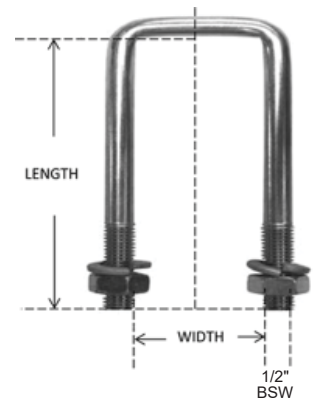

Square U-Bolts - Heavy Duty

	Length	45mm	50mm	63mm
Length	4.5"	UBOLT45X4.5SQ58	UBOLT50X4.5SQ58	N/A
	5.5"	UBOLT45X5.5SQ58	UBOLT50X5.5SQ58	N/A
	6"	UBOLT45X6SQ58	UBOLT50X6SQ58	N/A
	6.5"	UBOLT45X6.5SQ58	UBOLT50X6.5SQ58	N/A
	7"	UBOLT45X7SQ58	UBOLT50X7SQ58	UBOLT63X7SQ58
	8"	N/A	N/A	UBOLT63X8SQ58

(Supplied with 2 x M16 x 2.0 Nylocs and Flat Washers)

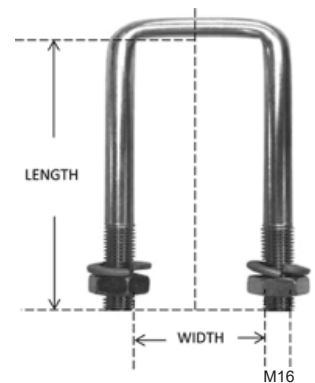

Round U-Bolts - Heavy Duty

	Length	65mm
Length	7"	UBOLT65X7RD58
	8"	UBOLT65X8RD58

(Supplied with 2 x M16 x 2.0 Nylocs and Flat Washers)

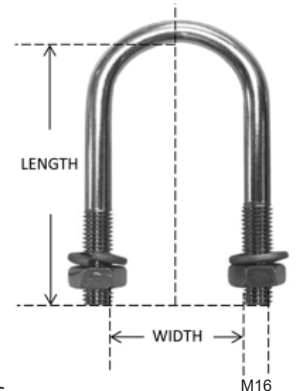

Identify U-Bolts For Spring Kit

AXLE + SPRING DEPTH (LEAF THICKNESS X NO. OF LEAVES) + 50mm
 (add 50mm extra to allow for nut to be secure on U-Bolts) = formula will give value in millimetres
 TO CONVERT TO INCHES ÷ 25.4

EXAMPLE

If U-Bolts are required for SPRING: 7mm, 9 leaf. AXLE: square 50mm:
 50 (axle) + 63 (7 x 9) + 50 (extra 50mm) = 163mm ÷ 25.4 = 6.41
 6 1/2" U-bolts required

Spring Kit - U-Bolts Cheat Sheet

Round U-Bolts

When using 8mm Fish Plates & 8mm Axle Pads, (For Slipper, Eye-Eye Shackle, Rocker Roller 3-7 Leaf, Tandem Eye-Eye Rocker Spring Sets)

	Leaf	39mm	45mm	50mm
Length 6mm	3	UBOLT39X4RD	UBOLT45X4.5RD	UBOLT50X4.5RD
	4	UBOLT39X4RD	UBOLT45X4.5RD	UBOLT50X4.5RD
	5	UBOLT39X4.5RD	UBOLT45X5RD	UBOLT50X5RD
	6	UBOLT39X5RD	UBOLT45X5RD	UBOLT50X5RD
	7	UBOLT39X5RD	UBOLT45X5RD	UBOLT50X5.5RD
	9	UBOLT39X5.5RD	UBOLT45X6RD	UBOLT50X6RD
8mm	3	UBOLT39X4RD	UBOLT45X4.5RD	UBOLT50X5RD
	4	UBOLT39X5RD	UBOLT45X5RD	UBOLT50X5RD
	5	UBOLT39X5RD	UBOLT45X5RD	UBOLT50X5RD

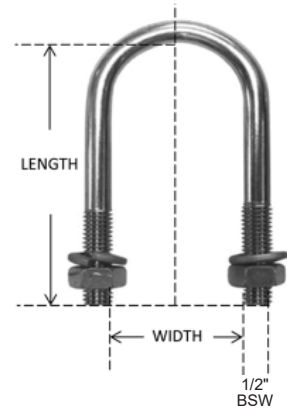

Square U-Bolts

When using 8mm Fish Plates & 8mm Axle Pads, (For Slipper, Eye-Eye Shackle, Rocker Roller 3-7 Leaf, Tandem Eye-Eye Rocker Spring Sets)

	Leaf	40mm	45mm	50mm
Length 6mm	3	UBOLT40X4.5SQ	UBOLT45X5SQ	UBOLT50X4.5SQ
	4	UBOLT40X4.5SQ	UBOLT45X5SQ	UBOLT50X5SQ
	5	UBOLT40X5SQ	UBOLT45X5SQ	UBOLT50X5SQ
	6	UBOLT40X5SQ	UBOLT45X5SQ	UBOLT50X5SQ
	7	UBOLT40X5SQ	UBOLT45X5SQ	UBOLT50X5.5SQ
	9	UBOLT40X5.5SQ	UBOLT45X6SQ	UBOLT50X6.5SQ
8mm	10	N/A	UBOLT45X6.5SQ	UBOLT50X7SQ
	3	UBOLT40X4.5SQ	UBOLT45X5SQ	UBOLT50X5SQ
	4	UBOLT40X5SQ	UBOLT45X5SQ	UBOLT50X5SQ
	5	UBOLT40X5SQ	UBOLT45X5.5SQ	UBOLT50X6SQ
6	N/A	UBOLT45X6SQ	N/A	

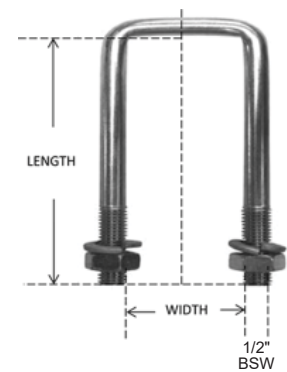

Note: 6-7 leaf Tri-Axle on 50SQ also use Heavy Duty U-bolts.

Square U-Bolts - Heavy Duty

When using 10mm Fish Plates & 10mm Axle Pads (Off Road Eye-Eye & 8-9 Leaf Rocker Roller)

	Leaf	45mm	50mm	63mm
Length 6mm	6	UBOLT45X5.5SQ58	UBOLT50X5.5SQ58	N/A
	7	UBOLT45X6SQ58	UBOLT50X6SQ58	N/A
	8	UBOLT45X6.5SQ58	UBOLT50X6.5SQ58	N/A
	9	UBOLT45X6.5SQ58	UBOLT50X7SQ58	UBOLT63X7SQ58
	10	N/A	N/A	UBOLT63X8SQ58

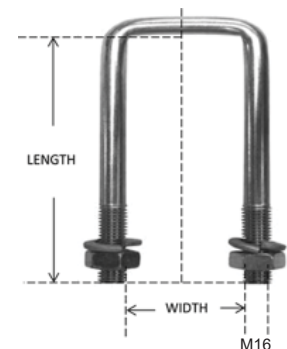

Note: 6-7 leaf Tri-Axle on 50SQ also use Heavy Duty U-Bolts.

Trailer Draw Bar U-Bolts

Item Code	A	B	C	Description
UBOLT3X3	73mm	75mm	1/2" BSW	U-Bolt 3" (Zinc Plated) For use with U Bolt swivel bracket. To suit 3" x 2" draw bar
UBOLT4X3	102mm	77mm	1/2" BSW	U-Bolt 4" (Zinc Plated) For use with U Bolt swivel bracket. To suit 4" x 2" draw bar
UBOLT3X4	78mm	102mm	1/2" BSW	U-Bolt 3" (Zinc Plated) For use with U Bolt swivel bracket. To suit 3" x 3" draw bar
UBOLT3X3GALV	78mm	77mm	1/2" BSW	U-Bolt 3" (Galvanised) For use with U Bolt swivel bracket. To suit 3" x 2" draw bar. Nuts/spring washers included
UBOLT4X3GALV	102mm	77mm	1/2" BSW	U-Bolt 4" (Galvanised) For use with U Bolt swivel bracket. To suit 4" x 2" draw bar. Nut/spring washers included
UBOLT3X4GALV	78mm	102mm	1/2" BSW	U-Bolt 3" (Galvanised) For use with U Bolt swivel bracket. To suit 3" x 3" draw bar. Nut/spring washers included
UBOLT-SPRWHL	95mm	N/A	1/2" BSW	U-Bolt - Spare Wheel (Zinc Plated) Designed for fixing spare wheel to draw bar.
UBOLT150X90	150mm	90mm	1/2" BSW	U-Bolt - (Zinc Plated) 150mm x 90mm to suit 6"x3" draw bar

(Supplied with 2 x 1/2" BSW Nuts and spring washers)

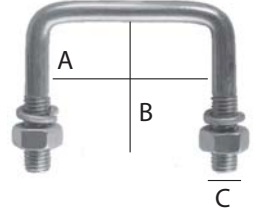

Agricultural U-Bolts

Item Code	A	B	C	Description
PWSEEDUBOLTSQ	45mm	65mm	10mm	U-Bolts for Adjustable Seed Tube Connecting Arms.

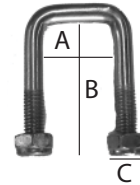

Item Code	A	B	C	Description
PWSEEDUBOLT	36mm	60mm	10mm	U-Bolts for Seed Boot Tube Connecting Arms
PWSEEDUBOLT100	36mm	100mm	10mm	100mm U-Bolts for Seed Boot Tube Connecting Arm
PWUBOLT/HARROW	75mm	120mm	16mm	U-Bolts to suit Harrow Arms

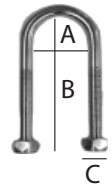

Item Code	A	B	C	Description
PWUBOLT/GANG	135mm	150mm	20mm	Gang Mounting Brackets
PWUBOLT/SHEARER	103mm	160mm	16mm	Diamond Back to suit Shearer

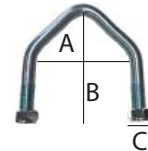

PWBRACKET-SHEARER	Cast Bracket to suit Shearer U-Bolts			
PWBRACKET-SHEARERHD	Fabricated Bracket to suit Shearer HD U-Bolts			



Item Code	A	B	C	Description
PWUBOLT/3X3-HT	78mm	115mm	16mm	High Tensile U-Bolts
PWUBOLT/3X3HD-HT	78mm	120mm	20mm	High Tensile U-Bolts
PWUBOLT/4X4-HT	103mm	145mm	16mm	High Tensile U-Bolts
PWUBOLT/4X4HD-HT	103mm	150mm	20mm	High Tensile U-Bolts
PWUBOLT/4X6HD-HT	103mm	202mm	20mm	High Tensile U-Bolts
PWUBOLT/6X6HD-HT	153mm	202mm	20mm	High Tensile U-Bolts
PWUBOLT/75X75-HT	75mm	115mm	16mm	High Tensile U-Bolts
PWUBOLT/100X100-HT	100mm	145mm	16mm	High Tensile U-Bolts
PWUBOLT/75X75HD-HT	75mm	115mm	16mm	High Tensile U-Bolts
PWUBOLT/100X100HD-HT	100mm	145mm	16mm	High Tensile U-Bolts

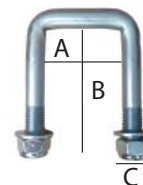

Agricultural U-Bolts

Item Code	A	B	C	Description
PW3SP-16	75mm	75mm	16mm	Shackle plate set to suit 3x3 (75x75) - 16mm
PW4SP-16	100mm	100mm	16mm	Shackle plate set to suit 4x4 (100x100) - 16mm
PW3SP-20	75mm	75mm	20mm	Shackle plate set to suit 3x3 (75x75) - 20mm
PW4SP-20	100mm	100mm	20mm	Shackle plate set to suit 4x4 (100x100) - 20mm
PW3X3X3SP	75mm	185mm	20mm	Shackle plate & bolts to suit 3x3 to 3x3 join - 20mm
PW3X3X4SP	75mm	210mm	20mm	Shackle plate & bolts to suit 3x3 to 4x4 join - 20mm

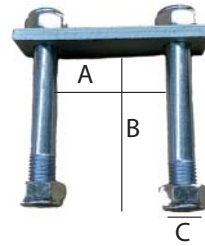

Item Code	A	B	Description
PW3X12SP	20mm	3"	Shackle plate 3" to suit 20mm bolts
PW4X12SP	20mm	4"	Shackle plate 4" to suit 20mm bolts

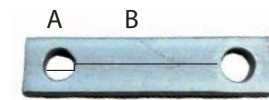

Item Code	A	B	C
PWUBOLT/25X60	25mm	60mm	1/2" BSW

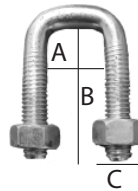

Item Code	A	B	C
PWUBOLT/50x60	50mm	60mm	1/2" BSW
PWUBOLT/50X85	50mm	85mm	1/2" BSW
PWUBOLT/50X125	50mm	125mm	1/2" BSW
PWUBOLT/50X185	50mm	185mm	1/2" BSW

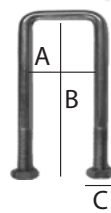

Item Code	A	B	C
PWUBOLT/80x90	80mm	90mm	16mm

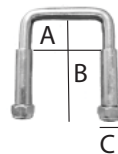

Item Code	A	B	C
PWUBOLT/25X100	25mm	100mm	1/2" BSW
PWUBOLT/30x100	30mm	100mm	1/2" BSW
PWUBOLT/40x100	40mm	100mm	1/2" BSW
PWUBOLT/30x60	30mm	60mm	1/2" BSW

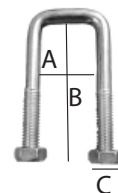

Item Code	A	B	C
PWUBOLT/80x105HD	78mm	115mm	20mm
PWUBOLT/80x115	78mm	115mm	16mm
PWUBOLT/105X125HD	103mm	145mm	20mm
PWUBOLT/105x145	103mm	145mm	16mm
PWUBOLT/80X75HD	80mm	100mm	20mm
PWUBOLT/105X100HD	105mm	125mm	20mm

