

Adjustable Stands



ASSW-L

Light Duty Adjustable Stand Side Winding
With pin locking swivel bracket welded in position

Outer Tube	50mm x 50mm x 3mm
Inner Tube	40mm x 40mm x 2.5mm
Lift	210mm
Unit Weight	7.1kg
Static Load Capacity	750kg
Finish	Zinc

Light Duty Side Winding

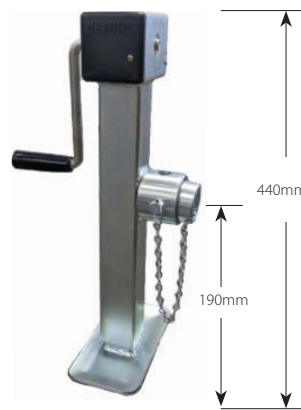

ASSW-LMT

Light Duty Adjustable Stand Side Winding
With swivel mounting tube welded in position

Outer Tube	50mm x 50mm x 3mm
Inner Tube	40mm x 40mm x 2.5mm
Lift	210mm
Unit Weight	5.8kg
Static Load Capacity	750kg
Finish	Zinc



ASSW-LN

Light Duty Adjustable Stand Side Winding
No swivel bracket or mounting tube

Outer Tube	50mm x 50mm x 3mm
Inner Tube	40mm x 40mm x 2.5mm
Lift	210mm
Unit Weight	4.8kg
Static Load Capacity	750kg
Finish	Zinc

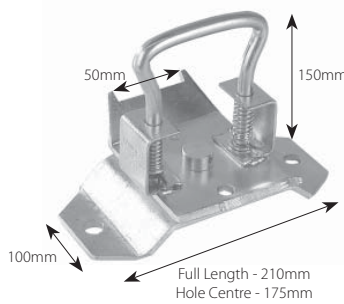

AS-LDSB50

Pin Locking Swivel Bracket
To suit ASSW-LN

Suit Outer Tube	50mm x 50mm
Unit Weight	2.2kg
Static Load Capacity	1000kg
Finish	Zinc
Hole Size	14mm

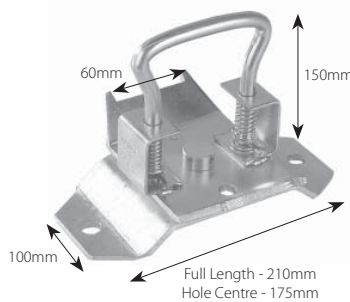

AS-LDSB1

Pin Locking Swivel Bracket
To suit ASSW-M

Suit Outer Tube	60mm x 60mm
Unit Weight	2.3kg
Static Load Capacity	1000kg
Finish	Zinc
Hole Size	14mm

Adjustable Stands

Medium Duty Side Winding



ASSW-M

Medium Duty Adjustable Stand
Side Winding
No swivel bracket or mounting tube

Outer Tube	60mm x 60mm x 4mm
Inner Tube	50mm x 50mm x 3mm
Lift	350mm
Unit Weight	8.6kg
Static Load Capacity	1000kg
Closed Height	575mm
Finish	Zinc

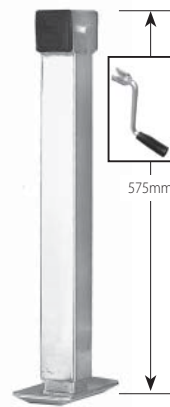

ASSW-MLH

Medium Duty Adjustable Stand
Side Winding
Loose handle, no swivel bracket
or mounting tube

Outer Tube	60mm x 60mm x 4mm
Inner Tube	50mm x 50mm x 3mm
Lift	350mm
Unit Weight	8.6kg
Static Load Capacity	1000kg
Closed Height	575mm
Finish	Zinc

WARNING: When using a power drill to adjust legs or stands, set drill on the lowest torque and speed setting. Failure to do so may result in damage to the internal components. **Strictly no impact drills!**

ASSW-MLHB-M-G

Medium Duty Adjustable Stand
Side Winding
Loose handle, with pin locking
swivel bracket

Outer Tube	60mm x 60mm x 4mm
Inner Tube	50mm x 50mm x 3mm
Lift	350mm
Unit Weight	11kg
Static Load Capacity	1000kg
Closed Height	575mm
Finish	Galv

Pin locking swivel bracket welded at 90mm from top

WARNING: When using a power drill to adjust legs or stands, set drill on the lowest torque and speed setting. Failure to do so may result in damage to the internal components. **Strictly no impact drills!**



ASSW-MLHB-H-G

Medium Duty Adjustable Stand
Side Winding
Loose handle, with pin locking
swivel bracket

Outer Tube	60mm x 60mm x 4mm
Inner Tube	50mm x 50mm x 3mm
Lift	350mm
Unit Weight	11kg
Static Load Capacity	1000kg
Closed Height	575mm
Finish	Galv

Pin locking swivel bracket welded at highest position

WARNING: When using a power drill to adjust legs or stands, set drill on the lowest torque and speed setting. Failure to do so may result in damage to the internal components. **Strictly no impact drills!**

ASSW-MLHB-G

Medium Duty Adjustable Stand
Side Winding
Loose handle, with pin locking
swivel bracket

Outer Tube	60mm x 60mm x 4mm
Inner Tube	50mm x 50mm x 3mm
Lift	350mm
Unit Weight	11kg
Static Load Capacity	1000kg
Closed Height	575mm
Finish	Galv

Pin locking swivel bracket welded at 120mm from top

WARNING: When using a power drill to adjust legs or stands, set drill on the lowest torque and speed setting. Failure to do so may result in damage to the internal components. **Strictly no impact drills!**



ASSW-M-RF ASSW-M-RFLH

Medium Duty Adjustable Stand
Side Winding
Fixed handle, or loose handle
removable rubber foot

Outer Tube	60mm x 60mm x 4mm
Inner Tube	50mm x 50mm x 3mm
Lift	350mm
Unit Weight	9.2kg
Static Load Capacity	1000kg
Closed Height	620mm
Foot Diameter	150mm
Finish	Zinc

AS-LOOSEHANDLE

Hex head socket type
to suit ASSW-MLH/DLLH

Handle loose 19mm



BEVGEARS-MK

Bevel gears for ASSW-M/MLH
series. Key way type

I.D.	12mm
O.D.	35.55mm
Teeth	15



PLASCAPS70X70

Plastic end caps, nuts and
bolts for ASSW-DL/H/M series

ID	60mm x 60mm
Fits Tube	70mm x 70mm
Caps	2



Adjustable Stands

Medium/Heavy Duty Side Winding

ASSW-DL

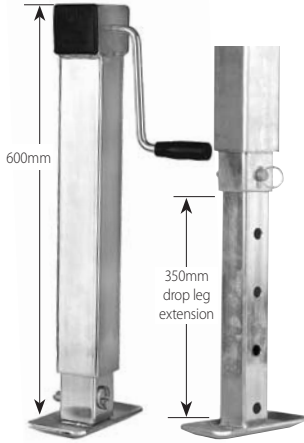

Heavy Duty Adjustable Stand Side Winding With drop leg

Outer Tube	70mm x 70mm x 4mm
Inner Tube	60mm x 60mm x 4mm
Drop Leg	50mm x 50mm x 3mm
Lift	350mm
Leg Extension	350mm
Max Extension	700mm
Unit Weight	11.6kg
Static Load Capacity	1500kg
Finish	Zinc

ASSW-DLLH

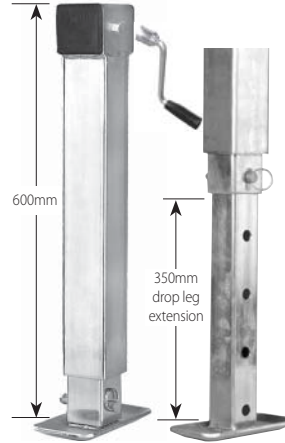

Heavy Duty Adjustable Stand Side Winding With drop leg and loose handle

Outer Tube	70mm x 70mm x 4mm
Inner Tube	60mm x 60mm x 4mm
Drop Leg	50mm x 50mm x 3mm
Lift	350mm
Leg Extension	350mm
Max Extension	700mm
Unit Weight	11.6kg
Static Load Capacity	1500kg
Finish	Zinc

WARNING: When using a power drill to adjust legs or stands, set drill on the lowest torque and speed setting. Failure to do so may result in damage to the internal components. **Strictly no impact drills!**

ASSW-DLLH-XL

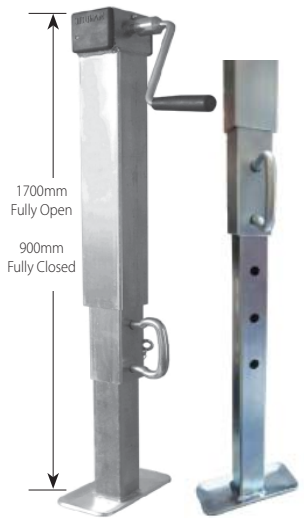

Medium Duty Adjustable Stand Side Winding Extra Long Loose handle

Outer Tube	70mm x 70mm x 4mm
Inner Tube	60mm x 60mm x 4mm
Drop Leg	50mm x 50mm x 3mm
Lift	350mm
Leg Extension	400mm
Max Extension	750mm
Unit Weight	15.1kg
Static Load Capacity	1000kg
Closed Height	900mm
Finish	Zinc

WARNING: When using a power drill to adjust legs or stands, set drill on the lowest torque and speed setting. Failure to do so may result in damage to the internal components. **Strictly no impact drills!**

ASSW-1.4M

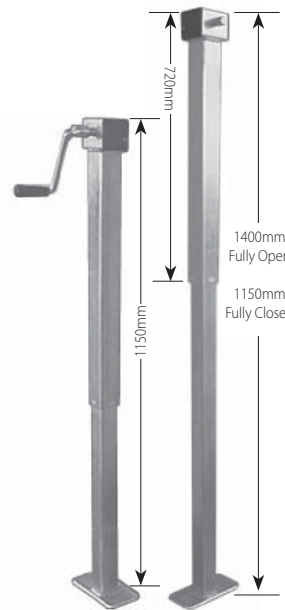

Medium Duty Adjustable Stand Side Winding Loose handle

Outer Tube	60mm x 60mm x 4mm
Inner Tube	50mm x 50mm x 3mm
Lift	250mm
Closed Height	1150mm
Unit Weight	12.2kg
Static Load Capacity	1000kg
Finish	Zinc

Note: Do not extend past 1.4m total height.

WARNING: When using a power drill to adjust legs or stands, set drill on the lowest torque and speed setting. Failure to do so may result in damage to the internal components. **Strictly no impact drills!**

AS-MT



Mounting Tubes Swivel For Adjustable Stands

Unit Weight	0.9kg
Static Load Capacity	1000kg

Inner Tube

OD	52mm
ID	40mm
Wall Thickness	6mm

Outer Tube

OD	65mm
ID	53mm
Wall Thickness	6mm

AS-HDSB1



Pin Locking Swivel Bracket For heavy duty Adjustable Stands. To suit ASSW-H & ASSW-DL

Plate Size	220mm x 140mm
Unit Weight	4.9Kg
Static Load Capacity	2000kg
Fits Tube	70mm x 70mm

Adjustable Stands



ASSW-H-RF

Heavy Duty Adjustable Stand
Side Winding - Fixed Handle
Removable rubber foot

Outer Tube	70mm x 70mm x 4mm
Inner Tube	60mm x 60mm x 4mm
Lift	350mm
Unit Weight	11.55kg
Static Load Capacity	2000kg
Closed Height	610mm
Foot Diameter	150mm
Finish	Zinc

Medium/Heavy Duty Side Winding

ASSW-1.0MT-LH



Medium Duty Adjustable Stand
Side Winding - Loose Handle
Welded AS-MT at highest position

Outer Tube	60mm x 60mm x 4mm
Inner Tube	50mm x 50mm x 4mm
Lift	350mm
Unit Weight	12.75kg
Static Load Capacity	1000kg
Closed Height	610mm
Finish	Zinc

WARNING: When using a power drill to adjust legs or stands, set drill on the lowest torque and speed setting. Failure to do so may result in damage to the internal components. **Strictly no impact drills!**

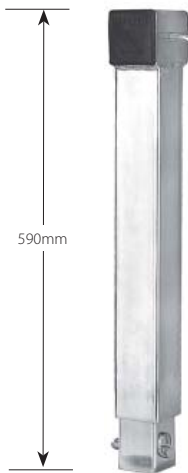

ASSW-LH-NDL

Heavy Duty Adjustable Stand
Side Winding - Loose Handle
No drop leg

Outer Tube	70mm x 70mm x 4mm
Inner Tube	60mm x 60mm x 4mm
Lift	350mm
Unit Weight	10.15kg
Static Load Capacity	1500kg*
Closed Height	580mm
ID	50mm
Finish	Zinc



ASSW-1.2MT

Medium Duty Adjustable Stand
Side Winding - Loose Handle
Welded AS-MT at highest position

Outer Tube	60mm x 60mm x 4mm
Inner Tube	50mm x 50mm x 4mm
Lift	350mm
Unit Weight	12.75kg
Static Load Capacity	1000kg
Closed Height	860mm
Finish	Zinc

* Note: With a standard steel drop leg fitted, the Static Load Capacity is 1500kg, however this will vary depending on which alternative leg is fitted



WARNING: When using a power drill to adjust legs or stands, set drill on the lowest torque and speed setting. Failure to do so may result in damage to the internal components. **Strictly no impact drills!**

Adjustable Stands

Heavy Duty & Extra Heavy Duty Side Winding

ASSW-DLHD

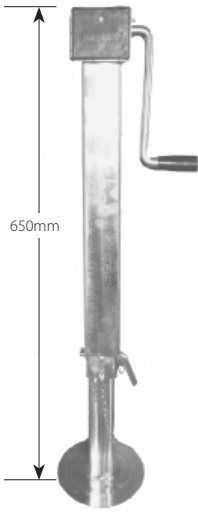

Extra Heavy Duty Adjustable Stand Side Winding - Fixed Handle Drop leg

Outer Tube	80mm x 80mm x 4mm
Inner Tube	70mm x 70mm x 4mm
Drop Leg	60mm x 60mm
Lift	260mm
Unit Weight	18.3kg
Static Load Capacity	2500kg
Closed Height	650mm
Leg Extension	280mm
Drive Ratio	2.5:1
5 Pin Position	70mm apart
Finish	Zinc

ASSW-HD

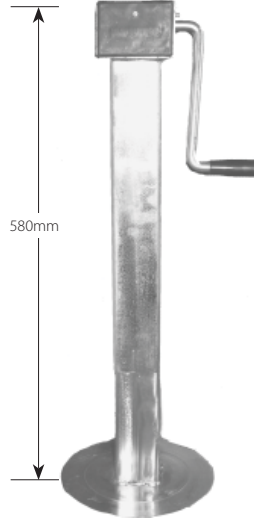

Extra Heavy Duty Adjustable Stand Side Winding - Fixed Handle

Outer Tube	80mm x 80mm x 4mm
Inner Tube	70mm x 70mm x 4mm
Lift	310mm
Unit Weight	15kg
Static Load Capacity	4000kg
Closed Height	580mm
Drive Ratio	2.5:1
Finish	Zinc
Foot Plate Diameter	220mm

ASSW-H

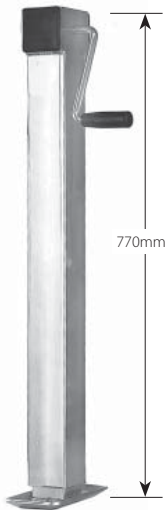

Heavy Duty Adjustable Stand Side Winding - Fixed Handle

Outer Tube	70mm x 70mm x 4mm
Inner Tube	60mm x 60mm x 4mm
Lift	350mm
Unit Weight	12.8kg
Closed Height	770mm
Static Load Capacity	2000kg
Finish	Zinc

ASSW-H-SHORT



Heavy Duty Short Adjustable Stand Side Winding - Fixed Handle

Outer Tube	70mm x 70mm x 4mm
Inner Tube	60mm x 60mm x 4mm
Lift	350mm
Unit Weight	11.65kg
Closed Height	610mm
Static Load Capacity	2000kg
Finish	Zinc

AS-MTHD

Heavy Duty Mounting Tubes Swivel For Adjustable Stands



Unit Weight	1.75kg
Static Load Capacity	4000kg

Inner Tube

OD	60mm
ID	44mm
Wall Thickness	8mm

Outer Tube

OD	76mm
ID	62mm
Wall Thickness	7mm

ASSW-HS-WP

Heavy Duty Short Adjustable Stand Side Winding - Fixed handle with welded plate

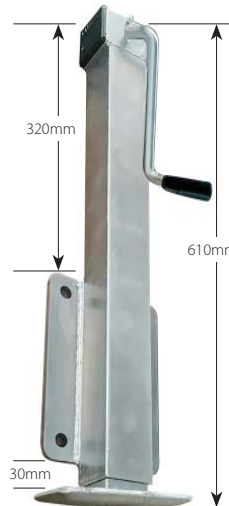

Outer Tube	70mm x 70mm x 4mm
Inner Tube	60mm x 60mm x 4mm
Lift	350mm
Unit Weight	15kg
Closed Height	610mm
Static Load Capacity	2000kg
Finish	Zinc
Bolt Pattern	4x18mm W120mm H200mm
Steel Plate	10mm x 250mm x 170mm

Adjustable Stands

Standard

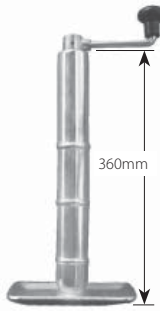
**AS14N**Standard
Adjustable Stand

Lift	225mm
Unit Weight	3.7kg
Static Load Capacity	650kg
Ridge Spacing	82mm

**AS20N**Standard
Adjustable Stand

Lift	225mm
Unit Weight	4.5kg
Static Load Capacity	650kg
Ridge Spacing	82mm

**AS27N**Standard
Adjustable Stand

Lift	225mm
Unit Weight	5.5kg
Static Load Capacity	650kg
Ridge Spacing	82mm

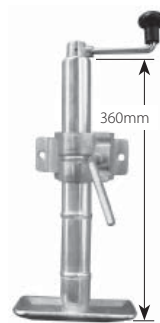
**AS14**Standard
Adjustable Stand
Including clamp

Lift	225mm
Unit Weight	4.7kg
Static Load Capacity	650kg
Ridge Spacing	82mm

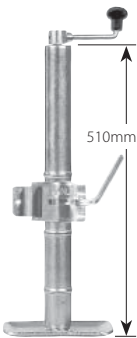
**AS20**Standard
Adjustable Stand
Including clamp

Lift	225mm
Unit Weight	5.5kg
Static Load Capacity	650kg
Ridge Spacing	82mm

**AS27**Standard
Adjustable Stand
Including clamp

Lift	225mm
Unit Weight	6.5kg
Static Load Capacity	650kg
Ridge Spacing	82mm

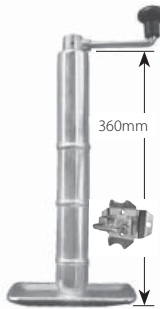
**AS14LB**Standard
Adjustable Stand
With pin locking swivel
bracket supplied loose

Lift	225mm
Unit Weight	5.9kg
Static Load Capacity	650kg
Ridge Spacing	82mm

**AS20LB**Standard
Adjustable Stand
With pin locking swivel
bracket supplied loose

Lift	225mm
Unit Weight	6.7kg
Static Load Capacity	650kg
Ridge Spacing	82mm

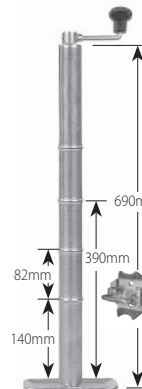
**AS27LB**Standard
Adjustable Stand
With pin locking swivel
bracket supplied loose

Lift	225mm
Unit Weight	7.6kg
Static Load Capacity	650kg
Ridge Spacing	82mm

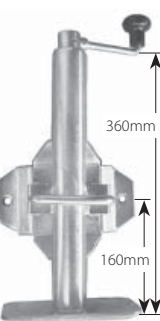
**AS14B**Standard
Adjustable Stand
With pin locking swivel
bracket welded in position

Lift	225mm
Unit Weight	5.9kg
Static Load Capacity	650kg

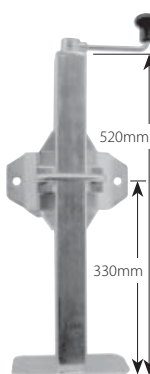
**AS20SQ**Standard
Adjustable Stand
With pin locking swivel
bracket welded in position

Square Tube	50mm x 50mm
Lift	225mm
Unit Weight	7.6kg
Static Load Capacity	650kg

LDSB1Pin Locking
Swivel BracketSee Section 2
- Page 25**Clamp**Bolt On/
Weld OnSee Section 2
- Page 24

Adjustable Stands

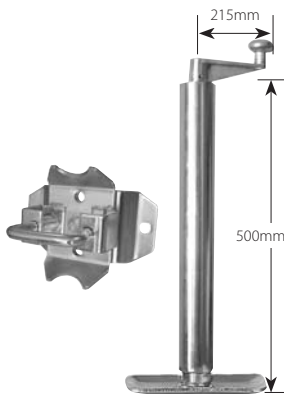

ASHD

Heavy Duty Adjustable Stand
With heavy duty pin locking swivel bracket supplied loose (HDSB1)

Outer Tube	60mm
Lift	225mm
Unit Weight	10.8kg
Static Load Capacity	1250kg
Closed Height	500mm



ASHDN

Heavy Duty Adjustable Stand

Outer Tube	60mm
Lift	225mm
Unit Weight	7.1kg
Static Load Capacity	1250kg
Closed Height	500mm



ASHDC

Heavy Duty Adjustable Stand
With heavy duty clamp weld on

Outer Tube	60mm
Lift	225mm
Unit Weight	10.3kg
Static Load Capacity	1250kg
Closed Height	500mm



ASHDXN

Heavy Duty Extra Height Adjustable Stand

Outer Tube	60mm
Lift	225mm
Unit Weight	10.0kg
Static Load Capacity	1250kg
Closed Height	700mm



ASHDX

Heavy Duty Extra Height Adjustable Stand
With heavy duty pin locking swivel bracket supplied loose (HDSB1)

Outer Tube	60mm
Lift	225mm
Unit Weight	13.7kg
Static Load Capacity	1250kg
Closed Height	700mm

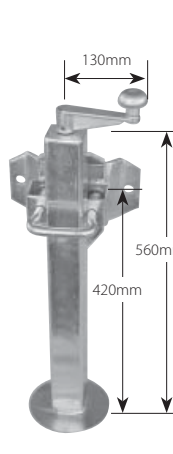

ASHD-SQ

Heavy Duty Adjustable Stand
Square tube with heavy duty swivel bracket welded on

Square Tube	60mm x 60mm
Lift	225mm
Unit Weight	11kg
Static Load Capacity	1250kg
Foot Plate Diameter	150mm
Closed Height	560mm

Also available ASHD-SQY in safety Yellow paint.



ASHDXC

Heavy Duty Extra Height Adjustable Stand
Heavy duty clamp weld on

Outer Tube	60mm
Lift	225mm
Unit Weight	13.2kg
Static Load Capacity	1250kg
Closed Height	700mm



HDSB1

Heavy Duty Pin Locking Swivel Bracket
Bolt-on/weld-on to suit heavy duty range of jockey wheel and stands

Suit Outer Tube	Heavy duty 60mm OD
Unit Weight	3.7kg
Dimensions	220mm (w) x 110mm (h)
Hole Size	16.5mm
Hole Centres	180mm
Plate Thickness	8mm

Adjustable Legs

Rear With Wheel

Zinc-weld on

Product Code	Length	Type	Handle	Unit Weight	Finish	Swing Arc
ALRM5	500mm	Metric thread	Hex-head handle fitting	3.7kg	Zinc	Away
ALRM6	600mm	Metric thread	Hex-head handle fitting	4.0kg	Zinc	Away
ALRP5	500mm	Power thread	Slotted handle fitting	3.5kg	Zinc	Toward
ALRP6	600mm	Power thread	Slotted handle fitting	3.8kg	Zinc	Toward

ALW75

3" solid rubber wheel to suit ALRM/ALRP rear legs



Front With No Wheel

Zinc-weld on

Product Code	Length	Type	Handle	Unit Weight	Finish	Swing Arc
ALFM5	500mm	Metric thread	Hex-head handle fitting	3.6kg	Zinc	Away
ALFM6	600mm	Metric thread	Hex-head handle fitting	3.8kg	Zinc	Away
ALFP5	500mm	Power thread	Slotted handle fitting	3.4kg	Zinc	Toward
ALFP6	600mm	Power thread	Slotted handle fitting	3.6kg	Zinc	Toward



ALFM6BOGA

Adjustable Leg Galv-Weld On

Brackets fitted - leg removable

Length	600mm
Front	No wheel
Type	Metric thread
Handle	Hex-head handle fitting
Unit Weight	4.6kg
Finish	Galvanised

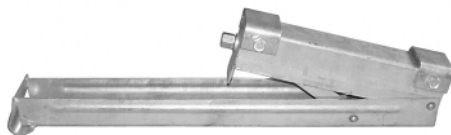

Handles

M Series Handles

Hex-head type - 19mm

Product Code	Length	Weight	Features
LH1M	600mm	740g	19mm Hex-Head
LH2M	700mm	840g	19mm Hex-Head
LH3M	900mm	1kg	19mm Hex-Head
LH2MD	590mm	600g	to be used on a drill

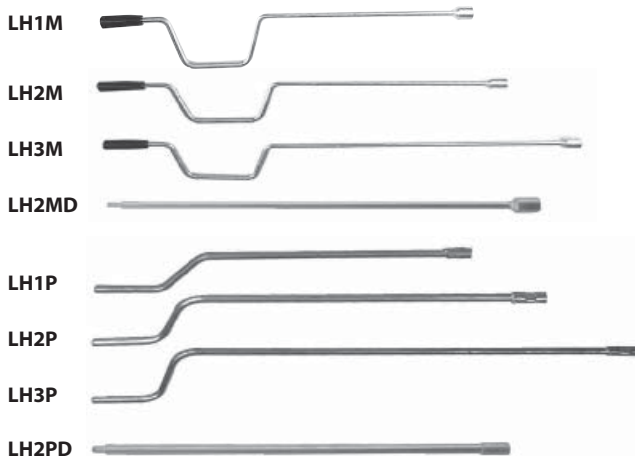

P Series Handles

Slotted type

Product Code	Length	Weight	Features
LH1P	550mm	560g	
LH2P	700mm	680g	
LH3P	900mm	840g	
LH2PD	570mm	500g	to be used on a drill

WARNING: When using a power drill to adjust legs or stands, set drill on the lowest torque and speed setting. Failure to do so may result in damage to the internal components. **Strictly no impact drills!**

Adjustable Legs (Corner Steadies) Zinc

Quick Release

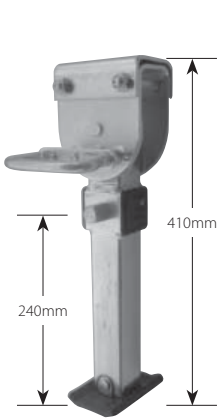

ALQR1

Adjustable Leg
Standard foot

Lift	120mm
Height	410mm
Unit Weight	4.7kg
Finish	Zinc



ALQR1-AF

Adjustable Leg
Aluminium foot

Lift	120mm
Height	410mm
Unit Weight	4.7kg
Finish	Zinc



ALQR1-HDFT

Adjustable Leg
Heavy duty foot

Lift	120mm
Height	410mm
Unit Weight	5.0kg
Finish	Zinc



ALQR1-AFP

Adjustable Leg
Plastic coated foot

Lift	120mm
Height	410mm
Unit Weight	4.7kg
Finish	Hammertone

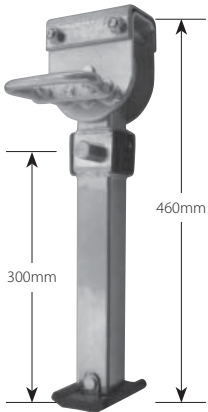

ALQR2

Adjustable Leg
Standard foot

Lift	180mm
Height	460mm
Unit Weight	5.1kg
Finish	Zinc



ALQR2-AF

Adjustable Leg
Aluminium foot

Lift	180mm
Height	460mm
Unit Weight	5.1kg
Finish	Zinc



ALQR2-HDFT

Adjustable Leg
Heavy duty foot

Lift	180mm
Height	460mm
Unit Weight	5.4kg
Finish	Zinc



ALQR2-AFP

Adjustable Leg
Plastic coated foot

Lift	180mm
Height	460mm
Unit Weight	5.1kg
Finish	Hammertone

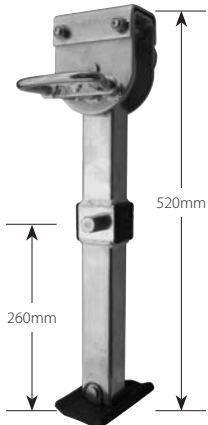

ALQR3

Adjustable Leg
Standard foot

Lift	140mm
Height	520mm
Unit Weight	5.7kg
Finish	Zinc



ALQR3-AF

Adjustable Leg
Aluminium foot

Lift	140mm
Height	520mm
Unit Weight	5.7kg
Finish	Zinc



ALQR3-HDFT

Adjustable Leg
Heavy duty foot

Lift	140mm
Height	520mm
Unit Weight	6.0kg
Finish	Zinc



ALQR3-AFP

Adjustable Leg
Plastic coated foot

Lift	140mm
Height	520mm
Unit Weight	5.7kg
Finish	Hammertone

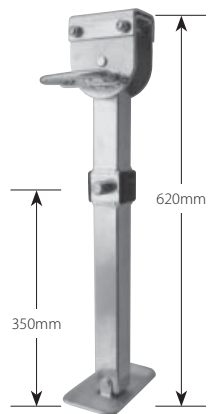

ALQR4LP

Adjustable Leg
Large plate foot

Lift	180mm
Height	620mm
Unit Weight	6.2kg
Finish	Zinc



ALQR4-AF

Adjustable Leg
Aluminium foot

Lift	180mm
Height	620mm
Unit Weight	6.2kg
Finish	Zinc



ALQR4-HDFT

Adjustable Leg
Heavy duty foot

Lift	180mm
Height	620mm
Unit Weight	6.5kg
Finish	Zinc



ALQR4-AFP

Adjustable Leg
Plastic coated foot

Lift	180mm
Height	620mm
Unit Weight	6.2kg
Finish	Hammertone

WARNING: When using a power drill to adjust legs or stands, set drill on the lowest torque and speed setting. Failure to do so may result in damage to the internal components. **Strictly no impact drills!**

Adjustable Legs (Corner Steadies) Black Quick Release

Adjustable Legs - Black

Matt black finish
 plastic coated handle
 galvanised inner leg
 black aluminium foot

	Product code	Height (H)	Base Height (B)	Lift (L)
1	ALQR1-BK	410mm	240mm	120mm
2	ALQR2-BK	460mm	300mm	180mm
3	ALQR3-BK	520mm	260mm	140mm
4	ALQR4-BK	620mm	350mm	180mm
5	ALQR5-BK	715mm	400mm	230mm



WARNING: When using a power drill to adjust legs or stands, set drill on the lowest torque and speed setting. Failure to do so may result in damage to the internal components. **Strictly no impact drills!**

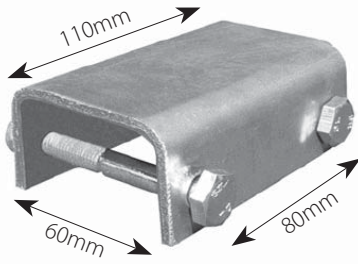

Every ALQR Comes With:
1x zinc bracket and 2x bolts & nuts.



ALQR3XL-AF (Zinc)
ALQR3XL-AFP (Hammertone)

Adjustable Leg
Aluminium / plastic coated foot

Lift	230mm
Height	520mm
Unit Weight	5.7kg
Finish	Zinc / Hammertone

Adjustable Legs

Hammertone finish with plastic coated foot

	Product code	Height (H)	Base Height (B)	Lift (L)
1	ALQR1-AFP	410mm	240mm	120mm
2	ALQR2-AFP	460mm	300mm	180mm
3	ALQR3-AFP	520mm	260mm	140mm
3XL	ALQR3XL-AFP	520mm	360mm	230mm
4	ALQR4-AFP	620mm	350mm	180mm
5	ALQR5-AFP	715mm	400mm	230mm



AL-ALQR1-3

Quick Release Adjustable Leg
Powder coated finish with plastic coated foot

Closed Height	430mm
Extension	160mm
Lift:	120mm
Extended Height	710mm
Replace	ALQR1, ALQR2, ALQR3

Australian Registered
Design Number: 201912530



AL-ALQR3-5

Quick Release Adjustable Leg
Powder coated finish with plastic coated foot

Closed Height	520mm
Extension	260mm
Lift:	240mm
Extended Height	1020mm
Replace	ALQR3, ALQR4, ALQR5

Australian Registered
Design Number: 201912530



WARNING: When using a power drill to adjust legs or stands, set drill on the lowest torque and speed setting. Failure to do so may result in damage to the internal components. **Strictly no impact drills!**

Adjustable Stands Spare Parts



JWBTR20

Thrust Race Bearing

ID	17mm
OD	35mm



Bronze Bush

Bush to suit ASSW-DL/H

AS-BB16	ID - 16mm (Vertical)
AS-BB17	ID - 17mm (Horizontal)

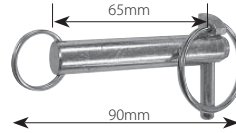

ASSW-LOCKPIN

Drop Leg Locking Pin
With linch pin for ASSW-DL/DLLH

Diameter	16mm
----------	------



AS-SPRINGPIN-DL/H

Coil Pin
To suit ASSW-DL/H 5mmX26mm,
to suit handles and acme thread



ASSW-DL-HEXSHAFT

Replacement Hex Head Shaft
To suit ASSW-DL/1.4M

Diameter	16mm
Hex	19mm
Overall Height	100mm



ASSW-LM-HEXSHAFT

Replacement Hex Head Shaft
To suit ASSW-LM

Diameter	12mm
Hex	19mm
Overall Height	100mm



SW-PLASHANDGRIP

Plastic Handle Grip
To suit side winding handles

ID	12mm
OD	35.55mm
Handle	12mm



AS-DROPLEG

Drop Leg To suit ASSW-DL/DLLH

Tube	50mm x 50mm
Length	450mm
Hole	17mm
Hole Spacing	85mm



Lifting Nut

ASNUT-M	16mm to suit screw of all ASSW-M/MLH
ASNUT-DL/H	22mm power thread to suit ASSW-DL/DLLH/H
ASNUT-HD	Lifting nut to suit ASSW-HD 30mm



Lifting Screw

ASSCREW-M	Lifting screw -16mm power thread for ASSW-M
ASSCREW-DL/H	Lifting screw -22mm (7/8") power thread for ASSW-DL/DLH/H
ASSCREW-HD	Lifting screw -30mm power thread for ASSW-HD



ASNUT/SCREW-1.4m

42mm Lifting Nut & Screw
To suit ASSW-1.4M



ASSW-RUBBERFOOT ASSW-RUBBERFOOT-50

Heavy Duty Circular Removable Grippped Rubber Foot
To suit the ASSW range with lock pin

Foot	155mm x 155mm x 16mm
Tube	40mm x 40mm / 50mm x 50mm
Overall Height	105mm

Plastic End Cap



PLAS-CAPS50x50	Plastic end caps (2) for ALQR suits 50mm x 50mm tube
PLAS-CAPS70x70	Plastic end caps (2) for ASSW-DL/H/M suits 70mm x 70mm tube ID: 60mm x 60mm
PLAS-CAPS-HD	Plastic end cap (2) for ASSW-HD suits 120mm x 80mm tube ID: 110mm x 70mm

Handles



	SW-FIXEDHDL12	SW-FIXEDHDL16	SW-FIXEDHDL-HD	AS-LOOSEHANDLE	AS-LDSB-HANDLE
Suit	ASSW-L/M	ASSW-DL/H	ASSW-HD	ASSW-MLH/DLLH	AS-LDSB1
Type	Gear Shaft	Gear Shaft	Gear Shaft	Socket	Swivel
Style	Fixed	Fixed	Fixed	Loose	Swivel
Handle	12mm	16mm	15mm	19mm	

Bevel Gears

BEVGEARS-MK	2 pcs Bevel Gears for ASSW-M models OD: 35.55mm Teeth: 15
BEVGEARS-DL/HK	2 pcs Bevel Gears for ASSW-DL/H models OD: 47.75mm Teeth: 17
BEVGEARS-HD	2 pcs Bevel Gears for ASSW-HD models SMALL: OD: 40mm Teeth: 10 LARGE: OD: 90mm Teeth: 25
BEVGEARS-ALQR (KEY WAY TYPE)	2 pcs Bevel Gears for ALQR legs ID: 13mm OD: 30mm Teeth: 12



ROLL PIN
4mm X 21mm

Adjustable Legs Spare Parts



PLASCAP-ALQTOP

Plastic Top Cap (1)
for ALQR

ID 42mm
OD 45mm



ALQR-QBOLT

Quick Release Bolt
For ALQR mounting bracket

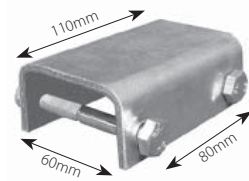

ALQR-MOUNTBRKT

Mounting Bracket
With Bolts/Nylocks for ALQR



ALQR-BKTBOLT

Bolt/Nyloc
For ALQR bracket

Diameter 9.5mm



ALQR-PIN

Pivot Pin to suit all ALQR feet

Diameter 11.9mm

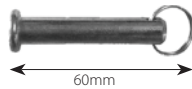

ALQR-PIN-SHORT

Pivot Pin to suit standard foot
only ALQR-STDPLASFT

Diameter 11.9mm



ALQR-HEXSHAFT

Winding Shaft With Hex Fit
for ALQR

Diameter 12mm

Hex 19mm

Overall Height 85mm



PLASCAPS50X50

Plastic end caps (2)
For ALQR suits

ID 42mm

OD 50mm



ALQR-FOOT-ALKO

Heavy Duty Steel Foot
With rubber cover, to suit ALKO leg,
includes pivot pin



ALQR-HDRUBFT

Heavy Duty Steel Foot
With rubber cover for ALQR leg

Dimensions 80 x 150 x 25mm

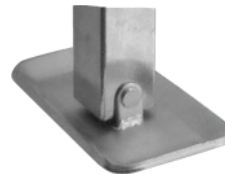

ALQR-LARGEPLATE

Large Steel Plate Foot
For ALQR leg

Dimensions 185mm x 95mm



ALQR-LGEALUMFT

Aluminium Foot Large
For ALQR leg

Dimensions 80 x 150 x 25mm



SHEARPIN-ALQR

Shear Pin
To suit ALQR

Dimensions 4mm x 20mm



ROLLPIN-ALQR

Roll Pin
To suit ALQR (hex head shaft)

Dimensions 4mmX19mm



ALQR-LGEALUMFT-SP

Aluminium Foot Plastic Coated

Dimensions 80 x 150 x 25mm



ALQR-SPRING/PINS

Pin, Spring & Clip
To suit ALQR-HANDLE



ALQR-HANDLE

Handle Set
To suit ALQR complete with
springs/washers/pins



ALQR-HANDLE-P

Plastic Coated Handle Set
To suit ALQR complete with
springs/washers/pins

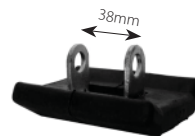

ALQR-STDPLASFT

Standard Metal Foot
With plastic cover for ALQR Leg

Dimensions 75mm x 110mm



JWBTR-ALQR

Thrust Race Bearing
To suit ALQR

ID 17mm

OD 31mm